

# Papierový model sondy - New Horizons

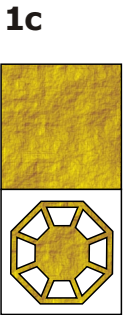
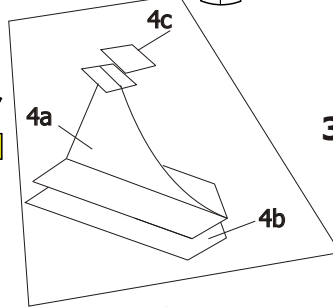
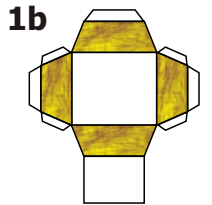
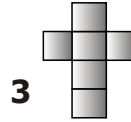
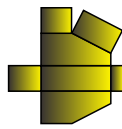
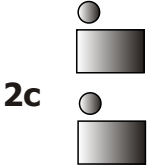
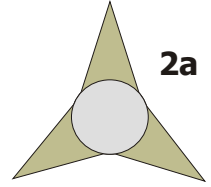
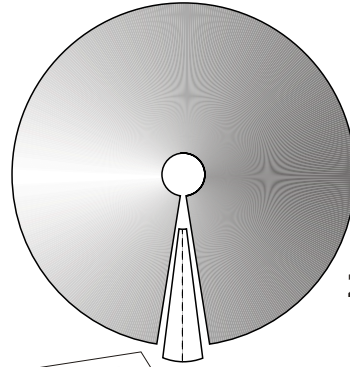
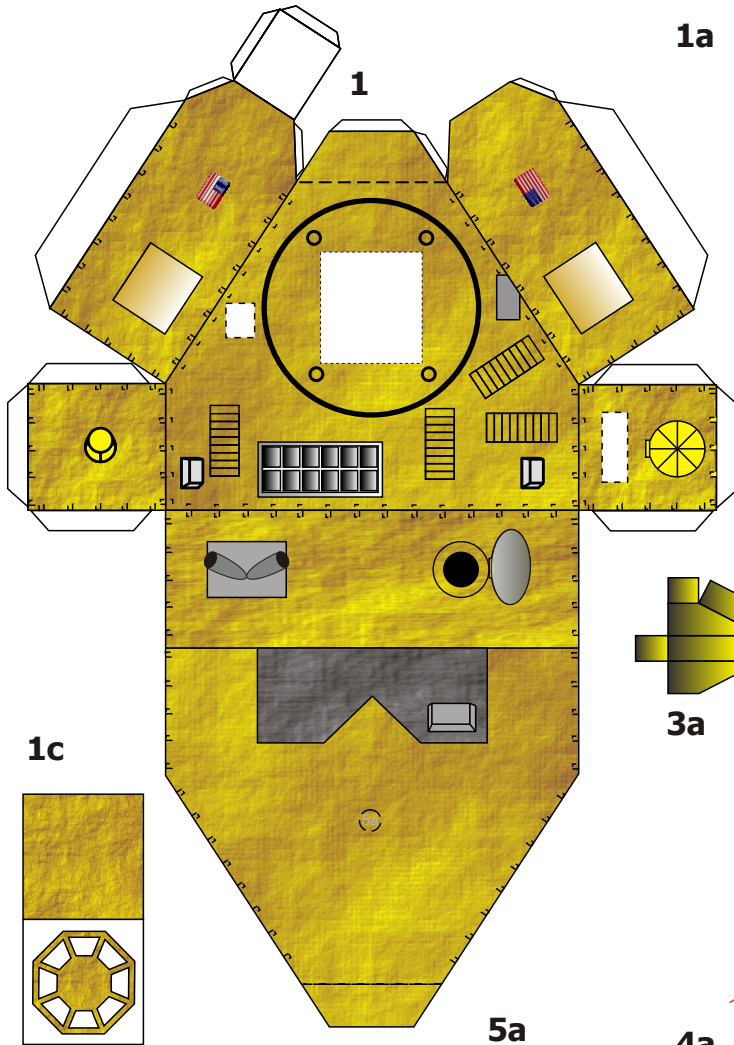

3a

3

1b

4a

4c

1c

5a

4a

5

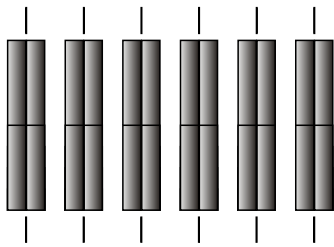
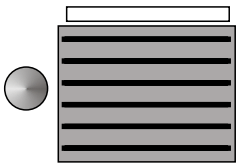

Diel 4b podlepiť kartónom 0,5 mm

By Tino Korinek



Krajská hviezdáreň a planetárium Maximiliána Hella v Žiari nad Hronom

4b

New horizons

Ako na to?

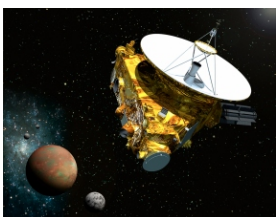
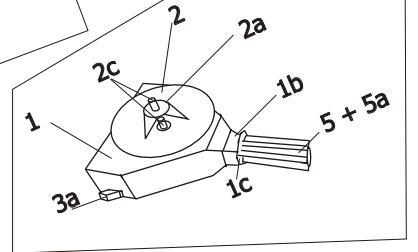

New Horizons je americká planetárna sonda, určená na prieskum trpasličej planéty Pluto, jej mesiacov a ďalších transneptúnskych telies (TNO). Je to jediná sonda, ktorá bola kedy vyslaná k Plutu. O tri a pol roka neskôr tiež dodala ľudstvu informácie z blízkeho preletu zo zatiaľ najvzdialenejšieho telesa od Slnka, aký kedy prebehol - z planétky 2014 MU69. Po svojom štarte 19. januára 2006 sa New Horizons stala najrýchlejšou sondou, akú kedy človek vypustil do vesmíru.